

# 634.015 DCGM 43 T42

DC MOTOR WITH WORM GEAR

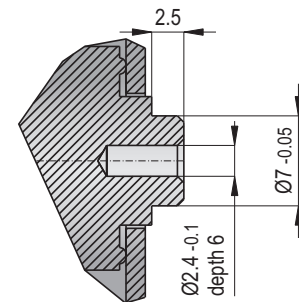
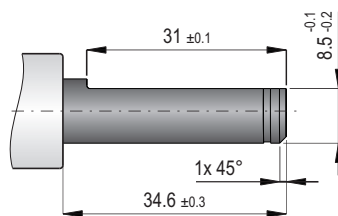
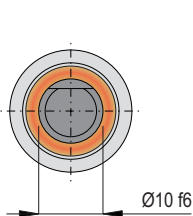
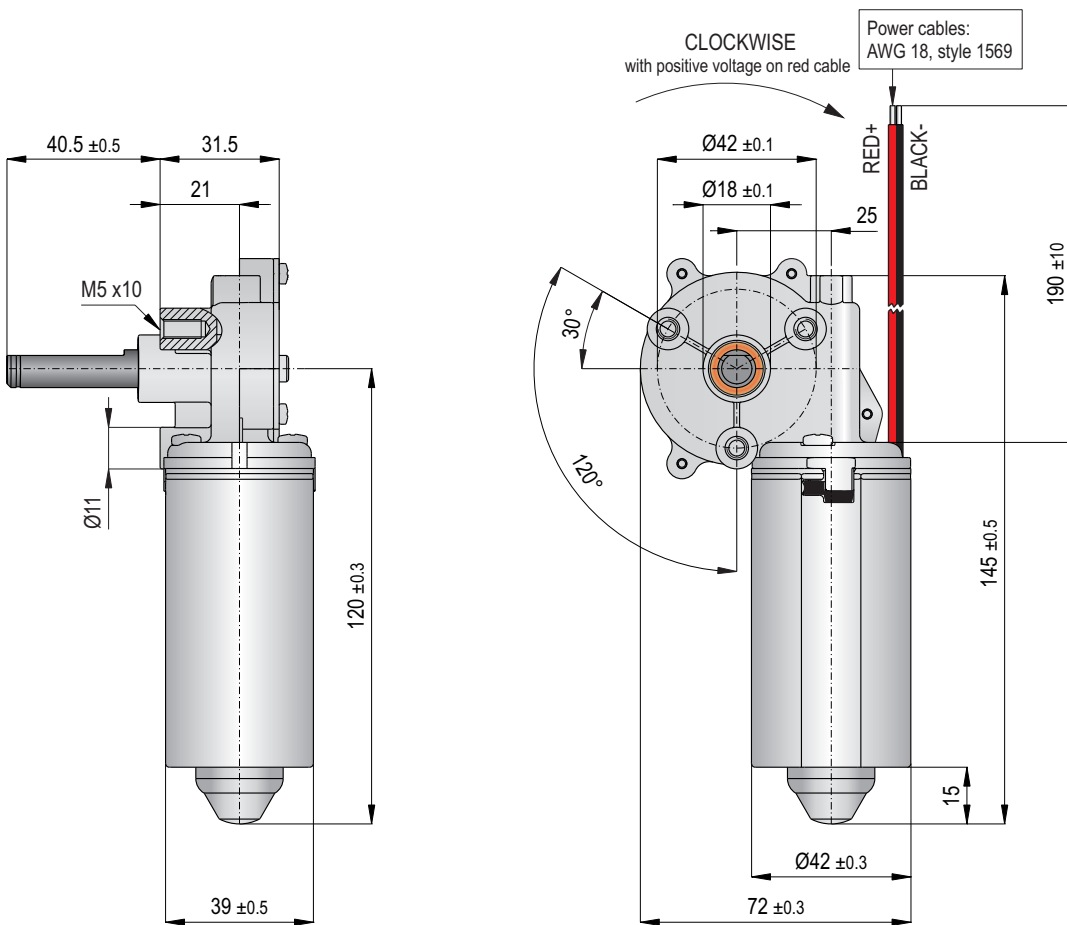

Ø 43 mm

24 V/DC

140 min<sup>-1</sup>

18 Nm

1,0 nF  
4,7 µH

-

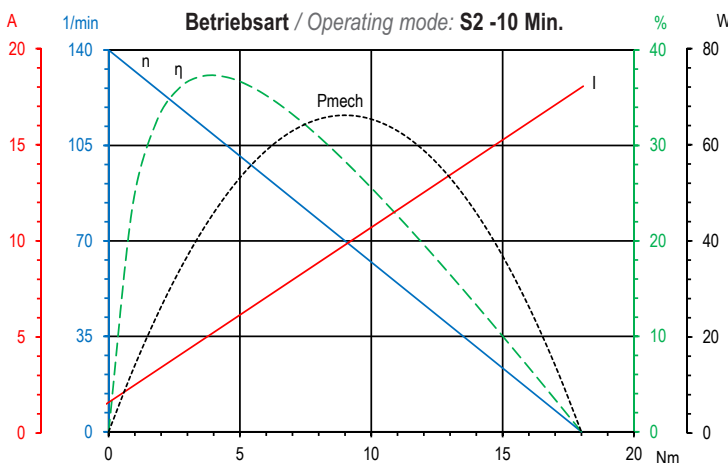

Diese Angaben sind Mittelwerte gemessen im kalten Zustand des Motors. Abweichungen von ±10% sind möglich. Technische Änderungen vorbehalten.  
These data are measured average values at cold engine. Deviations from ±10% are possible. Subject to change without notice.

## Technische Daten / Technical data

Nennspannung / Nominal voltage	<b>24 V/DC</b>
Leerlaufdrehzahl / No-load speed	<b>140 min<sup>-1</sup></b>
Nenn Drehmoment / Nom. torque	<b>2 Nm</b>
Anlaufmoment / Starting torque	<b>18 Nm</b>
Hall-Sensor / Hall sensor	-
Zahnradwerkstoff / Gear material	<b>Kunststoff / Plastic</b>
Übersetzung / Gear ratio	<b>62:1</b>
Schutzart / Protection class	<b>IP 20</b>
Gewicht / Weight	<b>0,7 kg</b>

634.015.01.3 - 2019.05.28

## Allgemeines

Alle Angaben zu DC-Motoren und DC-Linearantrieben sind Mittelwerte gemessen im kalten Zustand. Abweichungen von  $\pm 10\%$  sind möglich. Technische Änderungen vorbehalten.

Aktuelle Informationen finden Sie auf unserer Internetseite unter [www.seefrid.com](http://www.seefrid.com).

## General

All data to DC motors and DC linear actuators are measured average values at cold engine. Deviations from  $\pm 10\%$  are possible. Subject to change without notice.

Current information you will find on our website [www.seefrid.com](http://www.seefrid.com).

## Symbole / Symbols



Nennspannung [V]  
Nominal voltage [V]



Leerlaufdrehzahl [ $\text{min}^{-1}$ ]  
No-load speed [rpm]



Maximalmoment [Nm]  
Maximum torque [Nm]



Hubhöhe [mm]  
Stroke [mm]



Leerlaufgeschwindigkeit [mm/s]  
No-load speed [mm/s]



max. Hubkraft [N]  
max. lift power [N]



$\varnothing$  Motortopf [mm]  
Motor diameter [mm]



Motorbefestigung [mm]  
Mounting of motor [mm]



Hall-Sensor  
Hall sensor



EMV Entstörung  
EMC filter

## Allgemeines Anschlussschema für Motoren mit eingebautem Hall-Sensor

General connection diagram for motors with built-in Hall sensor

### • Anschlussschema mit 1-Kanal Hall-Sensor

Connection diagram with a 1-channel Hall sensor

### • Anschlussschema mit 2-Kanal Hall-Sensor

Connection diagram with a 2-channel Hall sensor



### Umrechnungen (für die Praxis gerundete Werte) / Conversion (rounded values)

• **Kräfte / Forces**

1 N = 0,1 kg = 100 g                      1 kg = 10 N = 10.000 mN

• **Drehmomente / Torques**

1 Nm = 10.000 g/cm = 10 kg/cm                      1 kg/cm = 0,1 Nm = 10 Ncm  
 1 Ncm = 100 g/cm = 0,1 kg/cm                      1 g/cm = 1·10<sup>-4</sup> Nm = 1·10<sup>-2</sup> Ncm

### Kennlinie / Diagram

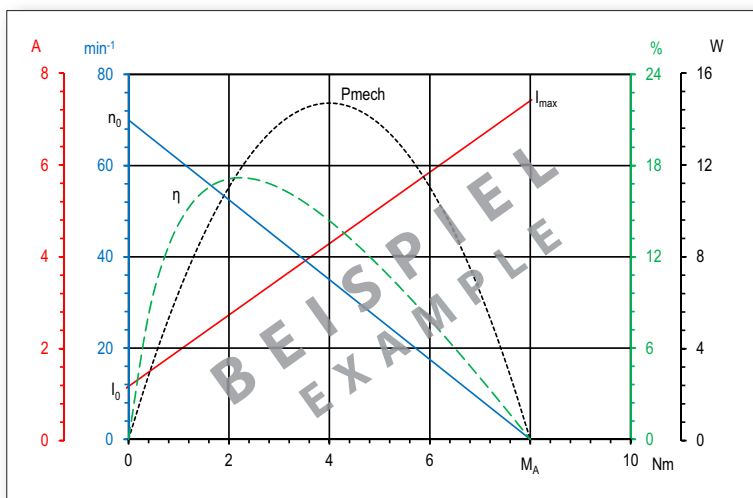

**Legende / Description**

- n<sub>0</sub> = Leerlaufdrehzahl / No-load speed [min<sup>-1</sup>]
- η = Wirkungsgrad / Efficiency [%]
- P<sub>mech</sub> = mech. Leistung / Mech. power [W]
- I<sub>0</sub> = Leerlaufstrom / No load current [A]
- I<sub>max</sub> = Maximalstrom / Max. current [A]
- M = Drehmoment / Torque [Nm]
- M<sub>A</sub> = Anlaufmoment / Starting torque [Nm]

### EMV-Entstörung / EMC filter

Ein Teil unserer DC-Motoren und DC-Linearantriebe sind mit Entstörkomponenten ausgestattet. Hierbei handelt es sich ausschließlich um eine Grundentstörung. Die tatsächlich notwendige Entstörung ist anwendungsabhängig zu ermitteln.

*Some of our DC motors and DC linear actuators have built-in EMC filter components. This is only a basic interference suppression. The really needed interference suppression must be determined in combination with the complete machine.*

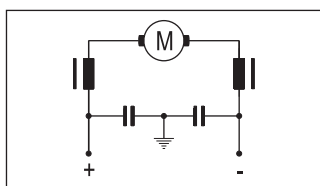

Kapazitive und induktive EMV-Entstörung. *EMC suppression with capacitor and choke.*

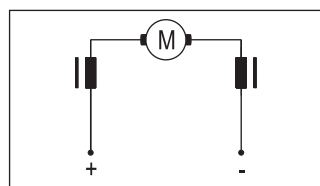

Induktive EMV-Entstörung. *EMC suppression with choke.*

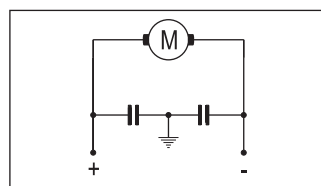

Kapazitive EMV-Entstörung. *EMC suppression with capacitor.*

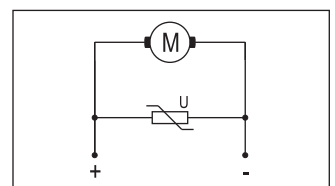

EMV-Entstörung mit einem Varistor. *EMC suppression with a varistor.*

Beispiel: / Example:



1,0 nF  
4,7 μH

Beispiel: / Example:



- nF  
4,7 μH

Beispiel: / Example:



1,0 nF  
- μH

Beispiel: / Example:



Varistor