

607.022 DCGM 76 T50

DC MOTOR WITH WORM GEAR



Ø 76 mm



24 V/DC



41 min⁻¹



45 Nm



-



-

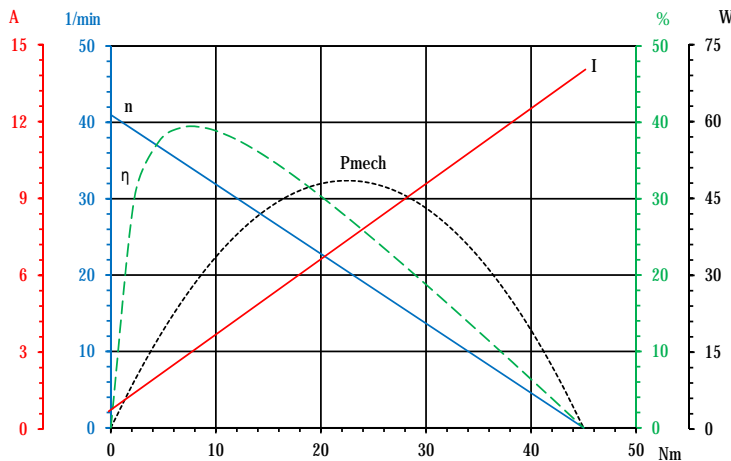
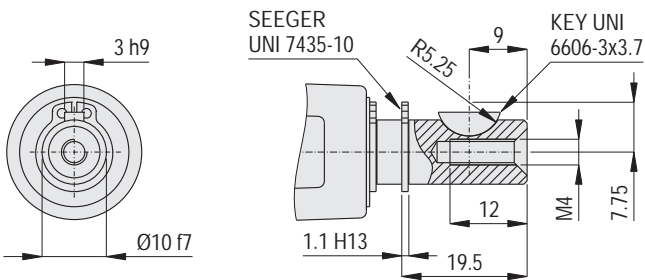
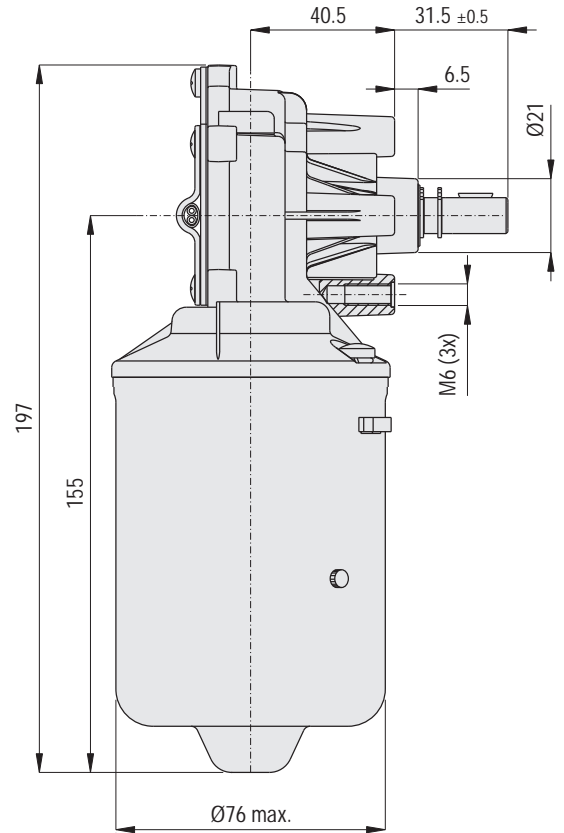
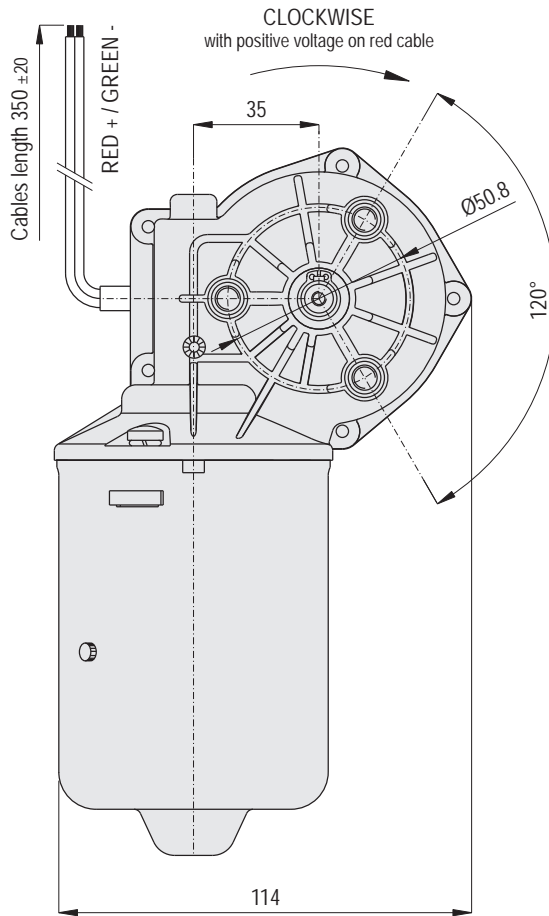

Diese Angaben sind Mittelwerte gemessen im kalten Zustand des Motors. Abweichungen von ±10% sind möglich. Technische Änderungen vorbehalten.
 These data are measured average values at cold engine. Deviations from ±10% are possible. Subject to change without notice.

Technische Daten / Technical data

Nennspannung / Nominal voltage	24 V/DC
Leerlaufdrehzahl / No-load speed	41 min⁻¹
Nenn Drehmoment / Nom. torque	10 Nm
Anlaufmoment / Starting torque	45 Nm
Hall-Sensor / Hall sensor	-
Zahnradwerkstoff / Gear material	Kunststoff / Plastic
Übersetzung / Gear ratio	49:1
Schutzart / Protection class	IP 30
Gewicht / Weight	1,6 kg

HK 2015

Allgemeines

Alle Angaben zu DC-Motoren und DC-Linearantrieben sind Mittelwerte gemessen im kalten Zustand. Abweichungen von $\pm 10\%$ sind möglich. Technische Änderungen vorbehalten.

Aktuelle Informationen finden Sie auf unserer Internetseite unter www.seefrid.com.

General

All data to DC motors and DC linear actuators are measured average values at cold engine. Deviations from $\pm 10\%$ are possible. Subject to change without notice.

Current information you will find on our website www.seefrid.com.

Symbole / Symbols



Nennspannung [V]
Nominal voltage [V]



Leerlaufdrehzahl [min^{-1}]
No-load speed [rpm]



Maximalmoment [Nm]
Maximum torque [Nm]



Hubhöhe [mm]
Stroke [mm]



Leerlaufgeschwindigkeit [mm/s]
No-load speed [mm/s]



max. Hubkraft [N]
max. lift power [N]



\varnothing Motortopf [mm]
Motor diameter [mm]



Motorbefestigung [mm]
Mounting of motor [mm]



Hall-Sensor
Hall sensor



EMV Entstörung
EMC filter

Allgemeines Hall-Sensor Anschlussschema / General Hall sensor connection diagram

- **Anschlussschema mit 1-Kanal Hall-Sensor**
Connection diagram with a 1-channel Hall sensor

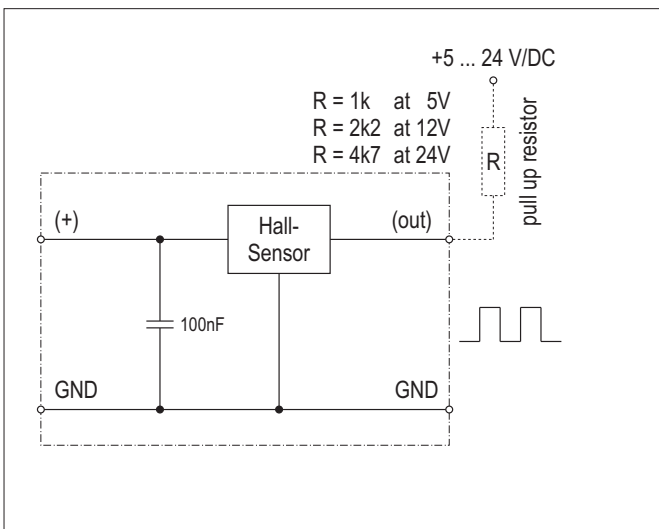

- **Anschlussschema mit 2-Kanal Hall-Sensor**
Connection diagram with a 2-channel Hall sensor

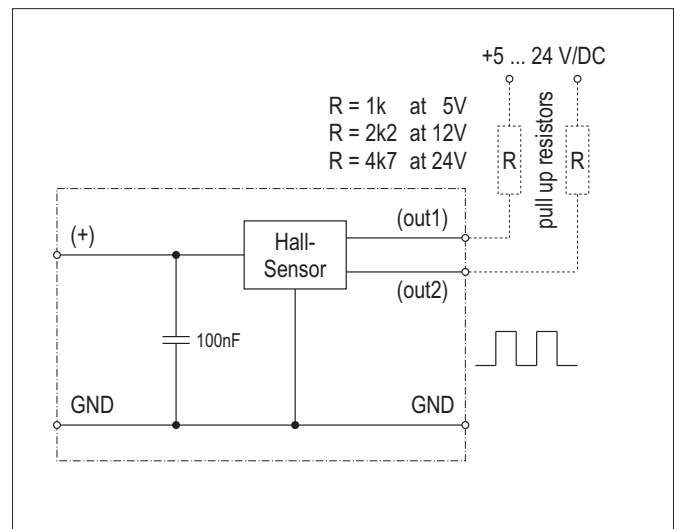

Umrechnungen (für die Praxis gerundete Werte) / Conversion (rounded values)

• **Kräfte / Forces**

1 N = 0,1 kg = 100 g 1 kg = 10 N = 10.000 mN

• **Drehmomente / Torques**

1 Nm = 10.000 g/cm = 10 kg/cm 1 kg/cm = 0,1 Nm = 10 Ncm
 1 Ncm = 100 g/cm = 0,1 kg/cm 1 g/cm = 1·10⁻⁴ Nm = 1·10⁻² Ncm

Kennlinie / Diagram

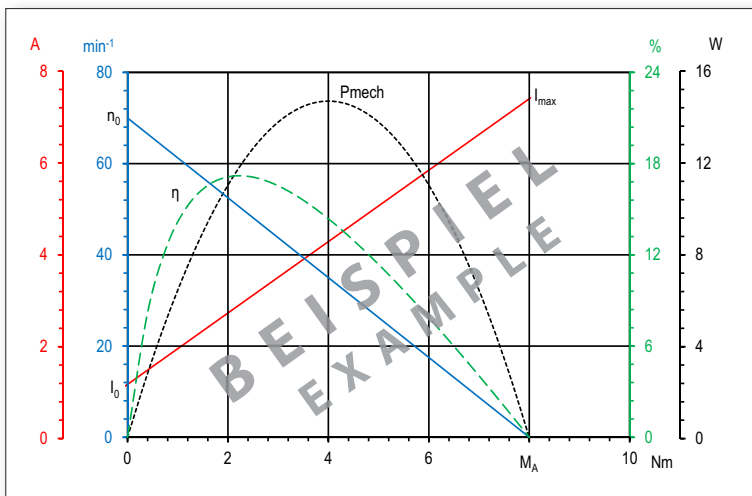

Legende / Description

- n₀ = Leerlaufdrehzahl / No-load speed [min⁻¹]
- η = Wirkungsgrad / Efficiency [%]
- P_{mech} = mech. Leistung / Mech. power [W]
- I₀ = Leerlaufstrom / No load current [A]
- I_{max} = Maximalstrom / Max. current [A]
- M = Drehmoment / Torque [Nm]
- M_A = Anlaufmoment / Starting torque [Nm]

EMV-Entstörung / EMC filter

Ein Teil unserer DC-Motoren und DC-Linearantriebe sind mit Entstörkomponenten ausgestattet. Hierbei handelt es sich ausschließlich um eine Grundentstörung. Die tatsächlich notwendige Entstörung ist anwendungsabhängig zu ermitteln.

Some of our DC motors and DC linear actuators have built-in EMC filter components. This is only a basic interference suppression. The really needed interference suppression must be determined in combination with the complete machine.

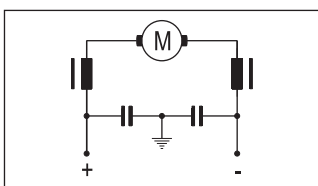

Kapazitive und induktive EMV-Entstörung. *EMC suppression with capacitor and choke.*

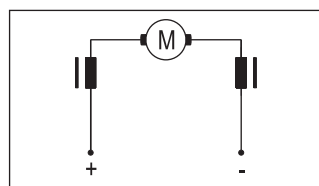

Induktive EMV-Entstörung. *EMC suppression with choke.*

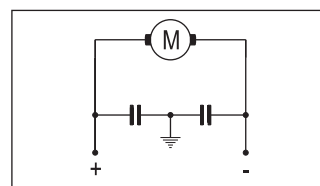

Kapazitive EMV-Entstörung. *EMC suppression with capacitor.*

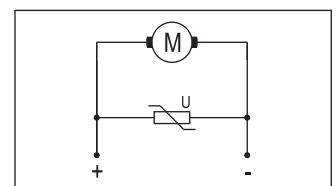

EMV-Entstörung mit einem Varistor. *EMC suppression with a varistor.*

Beispiel: / Example:



1,0 nF
4,7 μH

Beispiel: / Example:



- nF
4,7 μH

Beispiel: / Example:



1,0 nF
- μH

Beispiel: / Example:



Varistor